

SPECIFICATIONS : IDR-A RUBBER IN-SHEAR DOUBLE DEFLECTION FLOOR MOUNT ISOLATOR

Model	Rated Load		Rated Deflection		Approx. WT.	
	lb.	kN	in	mm	lbs.	kg
IDR-A-RED	15 to 100	0.067 to 0.445	0.5	12.7	0.45	0.21
IDR-A-BLUE	105 to 160	0.448 to 0.712	0.5	12.7	0.45	0.21
IDR-A-BLACK	175 to 250	0.779 to 1.113	0.5	12.7	0.45	0.21
IDR-A-GREEN	275 to 350	1.224 to 1.557	0.5	12.7	0.45	0.21
IDR-A-YELLOW	375 to 500	1.669 to 2.225	0.5	12.7	0.45	0.21

Model					
IDR-A					
L		W		H	
in	mm	in	mm	in	mm
3 7/8	99	2 5/16	59	1 3/4	48
T		M		øN	
in	mm	in	mm	in	mm
5/16	8	3	77	5/16	8

ISOLATOR'S LOCATIONS	
1:	5:
2:	6:
3:	7:
4:	8:

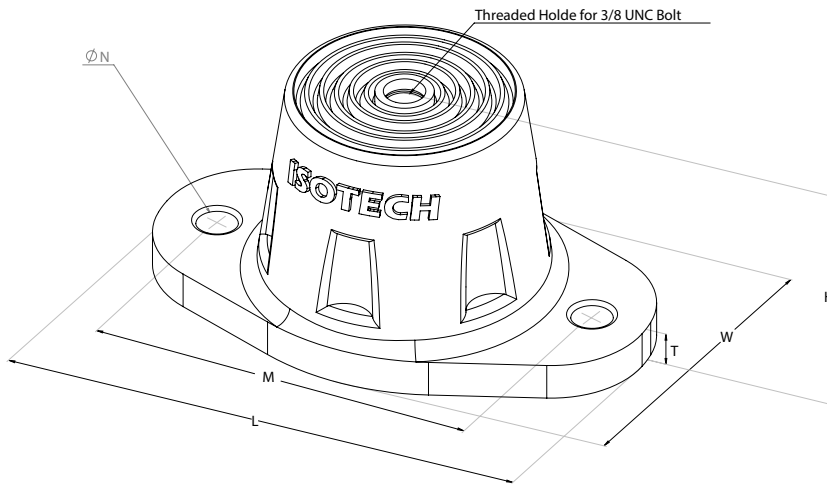
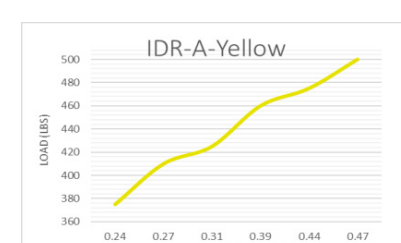
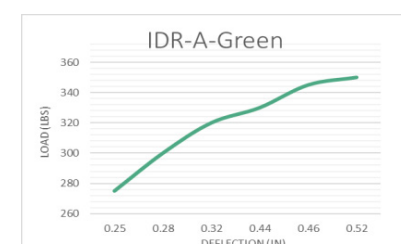
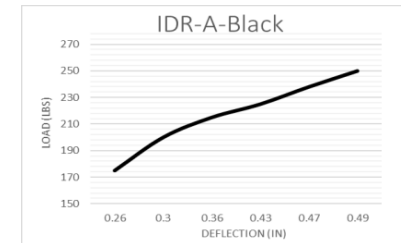
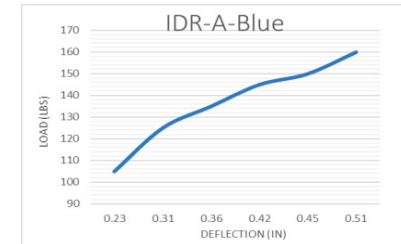
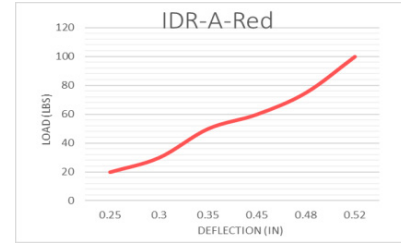
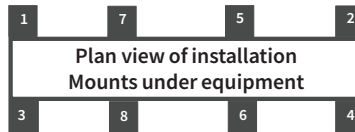

Notes:

- Bottom Surface and top surfaces are ribbed to enhance isolation efficiency
- IDR-A isolators include steel inserts embedded in neoprene for the full top and base areas

PROJECT INFORMATION		EQUIPMENT INFORMATION		Canada location	USA Location
Customer:		Type:		35 Silton Road Woodbridge ON L4L 7Z8 CANADA T: 905-856-5001	3021 E Coronado St. Anaheim, CA.,92806 U.S.A T: 949-788-2930
Project:		Qty Required:			
Drawing No:		Operating Weight:			
Notes:				Tool free : 1-888-831-3311 www.isotechindustries.com	

