

## SPECIFICATIONS - RUBBER-IN-SHEAR DOUBLE DEFLECTION FLOOR MOUNT

Model	Rated Load		Rated Deflection		Approx. WT.	
	lb.	KN	in	mm	lb.	Kg
IDR-A-RED	15 to 100	0.067 to 0.445	0.5	12.7	0.45	0.21
IDR-A-BLUE	105 to 160	0.448 to 0.712	0.5	12.7	0.45	0.21
IDR-A-BLACK	175 to 250	0.779 to 1.113	0.5	12.7	0.45	0.21
IDR-A-GREEN	275 to 350	1.224 to 1.557	0.5	12.7	0.45	0.21
IDR-A-YELLOW	375 to 500	1.669 to 2.225	0.5	12.7	0.45	0.21

Model					
IDDR-A					
L		W		H	
in	mm	in	mm	in	mm
3 7/8	99	6 5/16	59	1 7/8	48
T		M		øD	
in	mm	in	mm	in	mm
5/16	8	3	77	1 3/4	45
ød		øN			
in	mm	in	mm		
3/8	-	5/16	8		

ISOLATOR'S LOCATIONS			
1:		4:	
2:		5:	
3:		6:	

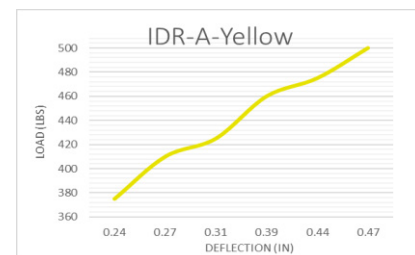
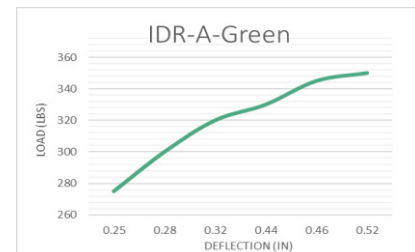
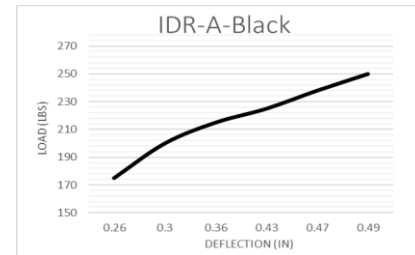
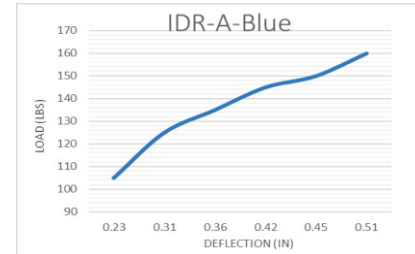
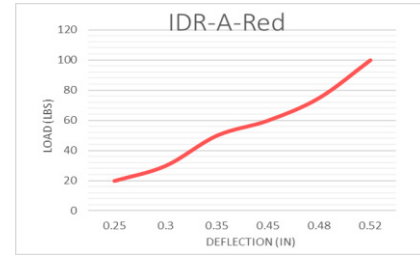
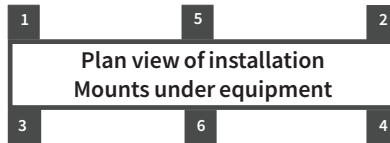

**Notes:**

- Bottom Surface and top surfaces are ribbed to enhance isolation efficiency
- IDR-A isolators include steel inserts embedded in neoprene for the full top and base areas

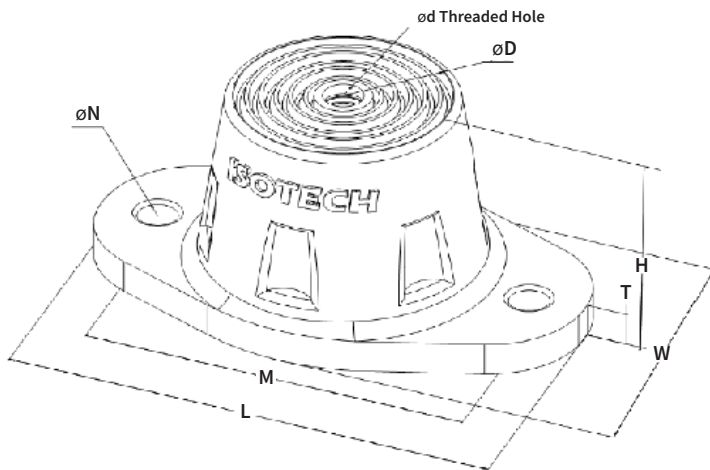

PROJECT INFORMATION		EQUIPMENT INFORMATION		Canada location	USA Location	
Customer:		Type:		35 Silton Road Woodbridge ON L4L 7Z8 CANADA T: 905-856-5001	7700 Irvine Centre Drive Suite 800 Irvine, CA, 92618 U.S.A T: 949-788-2930	
Project:		Qty Required:				
Drawing No:		Operating Weight:				
Notes:				<a href="http://www.isotechindustries.com">www.isotechindustries.com</a>		

## SPECIFICATIONS - RUBBER-IN-SHEAR DOUBLE DEFLECTION FLOOR MOUNT

Model	Rated Load		Rated Deflection		Approx. WT.	
	Lb.	KN	in	mm	Lb.	Kg
IDR-A-RED	15 to 100	0.067 to 0.445	0.5	12.7	0.45	0.21
IDR-A-BLUE	105 to 160	0.448 to 0.712	0.5	12.7	0.45	0.21
IDR-A-BLACK	175 to 250	0.779 to 1.113	0.5	12.7	0.45	0.21
IDR-A-GREEN	275 to 350	1.224 to 1.557	0.5	12.7	0.45	0.21
IDR-A-YELLOW	375 to 500	1.669 to 2.225	0.5	12.7	0.45	0.21

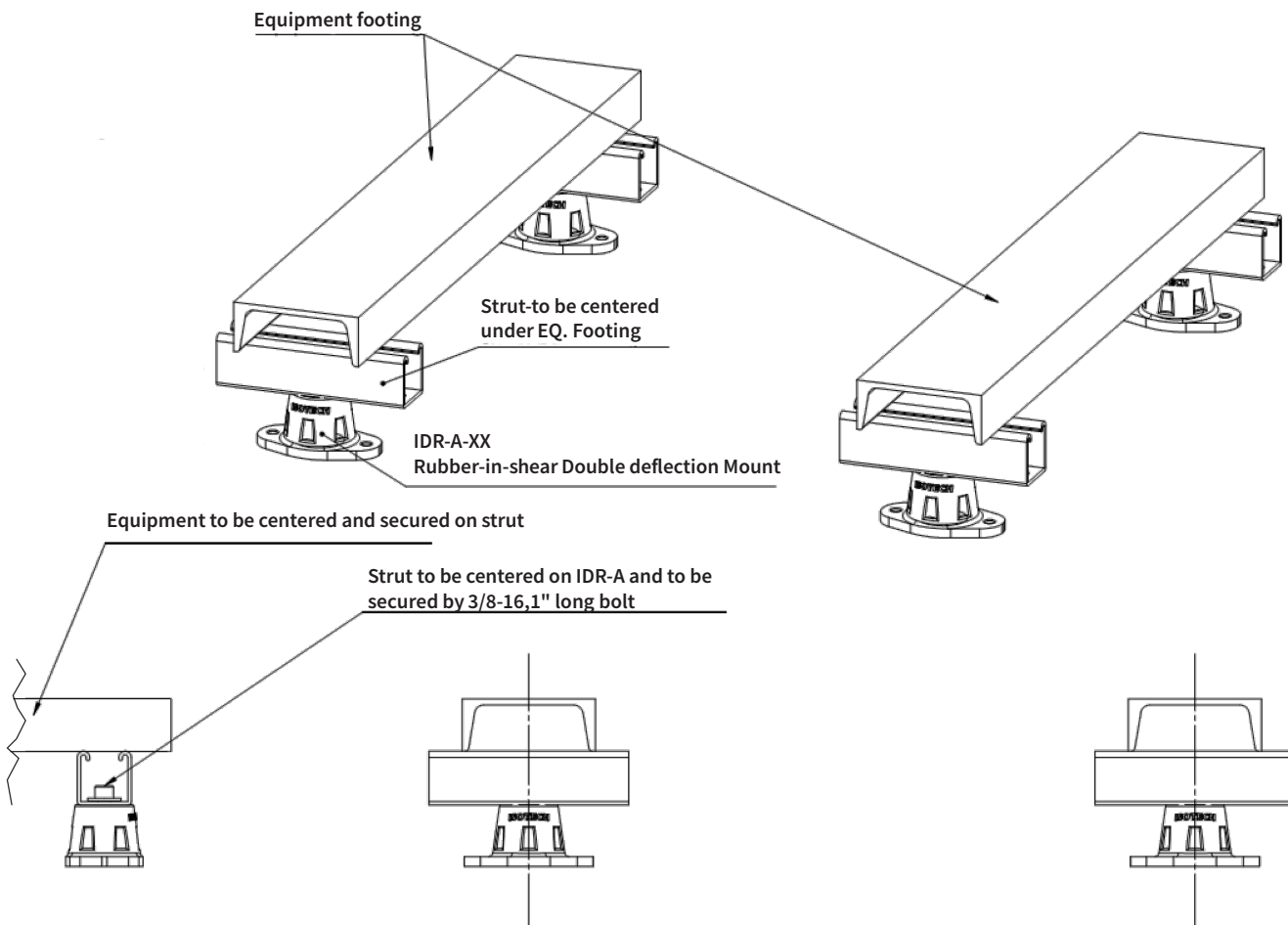

PROJECT INFORMATION		EQUIPMENT INFORMATION		Canada location	USA Location	
Customer:		Type:		35 Silton Road Woodbridge ON L4L 7Z8 CANADA T: 905-856-5001	7700 Irvine Centre Drive Suite 800 Irvine, CA, 92618 U.S.A T: 949-788-2930	
Project:		Qty Required:				
Drawing No:		Operating Weight:				
Notes:				<a href="http://www.isotechindustries.com">www.isotechindustries.com</a>		