

SPECIFICATIONS - RUBBER-IN-SHEAR DOUBLE DEFLECTION FLOUR MOUNT

Model	Rated Load		Rated Deflection		Approx. WT.	
	lb.	KN	in	mm	lb.	Kg
IDDR-A-RED	30 to 200	0.134 to 0.890	0.5	12.7	2.5	1.14
IDDR-A-BLUE	210 to 320	0.896 to 1.424	0.5	12.7	2.5	1.14
IDDR-A-BLACK	350 to 500	1.558 to 2.226	0.5	12.7	2.5	1.14
IDDR-A-GREEN	550 to 700	2.448 to 3.114	0.5	12.7	2.5	1.14
IDDR-A-YELLOW	750 to 1000	3.338 to 4.450	0.5	12.7	2.5	1.14

Model					
IDDR-A					
L		W1		H	
in	mm	in	mm	in	mm
3 7/8	99	6	153	3 1/2	89
T		M		W2	
in	mm	in	mm	in	mm
5/16	8	3	77	3 1/2	89
øN					
in	mm				
5/16	8				

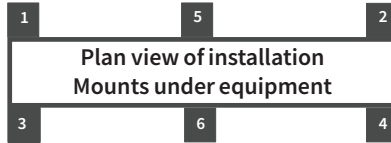
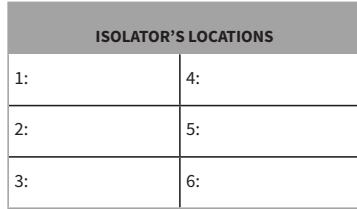

Notes:

- Bottom Surface and top surfaces are ribbed to enhance isolation efficiency
- IDDR-A isolators include steel inserts embedded in neoprene for the full top and base areas

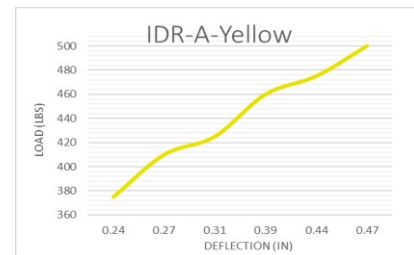
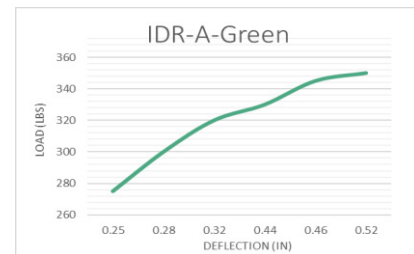
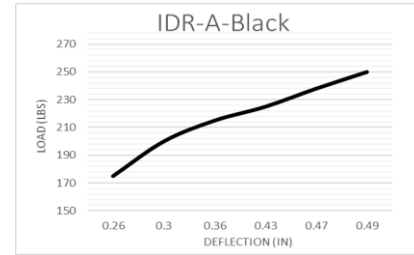
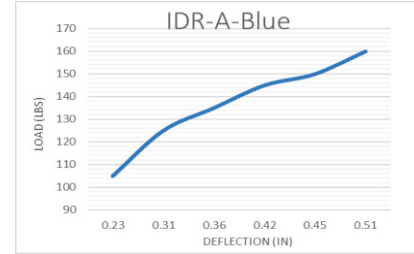
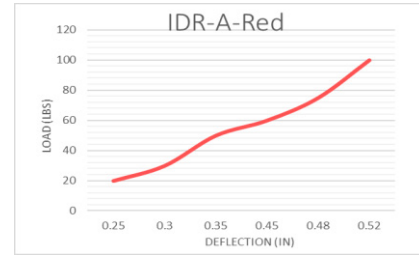
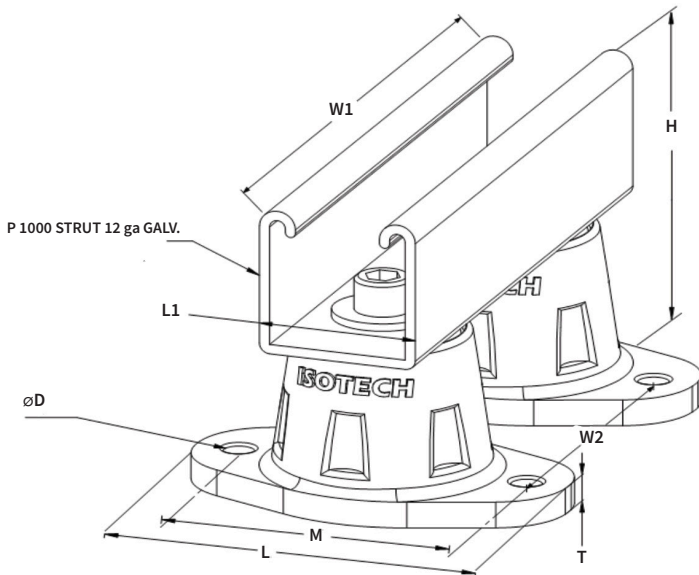

PROJECT INFORMATION		EQUIPMENT INFORMATION		Canada location	USA Location	
Customer:		Type:		35 Silton Road Woodbridge ON L4L 7Z8 CANADA T: 905-856-5001	7700 Irvine Centre Drive Suite 800 Irvine, CA, 92618 U.S.A T: 949-788-2930	
Project:		Qty Required:				
Drawing No:		Operating Weight:				
Notes:				www.isotechindustries.com		